

95Ci Upright Exercise Bike

operation manual



LifeFitness

CORPORATE HEADQUARTERS

10601 West Belmont Avenue
Franklin Park, Illinois 60131 • U.S.A.
847.288.3300 • FAX: 847.288.3703
800.735.3867 (Toll-free within U.S.A., Canada)

www.lifefitness.com

INTERNATIONAL OFFICES

LIFE FITNESS ASIA PACIFIC LTD

Room 2610, Miramar Tower
132 Nathan Road
Tsimshatsui, Kowloon
HONG KONG
Telephone: (+852) 2891.6677
FAX: (+852) 2575.6001

LIFE FITNESS ATLANTIC BV

LIFE FITNESS BENELUX
Bijdorpplein 25-31
2992 LB Barendrecht
THE NETHERLANDS
Telephone: (+31) 180.646.666
FAX: (+31) 180.646.699
Telephone: (+32) 87.300.942
FAX: (+32) 87.300.943

LIFE FITNESS DO BRAZIL

Av. Dr. Dib Sauaia Neto 1478
Alphaville, Barueri, SP
06465-140
BRAZIL
Telephone (+55) 11.4193.8282
FAX: (+55) 11.4193.8283

LIFE FITNESS VERTRIEBS GMBH

Dückerstraße 7-9/3/36
1220 Vienna
AUSTRIA
Telephone: (+43) 1.61 57 198
FAX: (+43) 1.61 57 198.20

LIFE FITNESS IBERIA

Pol. Ind. Molí dels Frares. c/C, nº 12
08620 Sant Vicenç dels Horts (Barcelona)
SPAIN
Telephone: (+34) 93.672.4660
FAX: (+34) 93.672.4670

LIFE FITNESS EUROPE GMBH

Siemensstraße 3
85716 Unterschleißheim
GERMANY
Telephone: (+49) 89.31 77 51.0
FAX: (+49) 89.31 77 51.99

LIFE FITNESS ITALIA S.R.L.

Via Vittorio Veneto, 57/A
39042 Bressanone (Bolzano)
ITALY
Telephone: (+39) 0472.835 470
FAX: (+39) 0472.833 150

LIFE FITNESS LATIN AMERICA and CARIBBEAN

10601 West Belmont Avenue
Franklin Park, Illinois 60131
U.S.A.
Telephone: (+1) 847.288.3300
FAX: (+1) 847.288.3886

LIFE FITNESS UK LTD

Queen Adelaide
Ely, Cambs CB7 4UB
UNITED KINGDOM
Telephone: (+44) 1353.666017
FAX: (+44) 1353.666018

LIFE FITNESS JAPAN

Nippon Brunswick Bldg., #8F
5-27-7 Sendagaya
Shibuya-Ku, Tokyo
JAPAN 151-0051
Telephone: (+81) 3.3359.4309
FAX: (+81) 3.3359.4307

M051-00K63-A064

06.03

Before using this product, it is essential to read this ENTIRE operation manual and ALL installation instructions.

This will help in setting up the equipment quickly and in instructing others on how to use it correctly and safely.

Avant toute utilisation de ce produit, il est indispensable de lire ce manuel d'utilisation dans son INTÉGRALITÉ, ainsi que TOUTES les instructions d'installations.

Ce manuel explique comment installer l'équipement et comment l'utiliser correctement et sans danger.

FCC Warning - Possible Radio / Television Interference

NOTE: *This equipment has been tested and found to comply with the limits for a Class A digital device, pursuant to part 15 of the FCC rules. These limits are designed to provide reasonable protection against harmful interference when the equipment is operated in a commercial environment. This equipment generates, uses and can radiate radio frequency energy, and if not installed and used in accordance with the operation manual, may cause harmful interference to radio communications. Operation of this equipment in a residential area is likely to cause harmful interference in which case the user will be required to correct the interference at his own expense.*

Class S (Studio): Professional and / or commercial use.



CAUTION: Any changes or modifications to this equipment could void the product warranty.



MISE EN GARDE: Tout changement et toute modification de ce matériel peut annuler la garantie du produit.

Any service, other than cleaning or user maintenance, must be performed by an authorized service representative. There are no user-serviceable parts.

TABLE OF CONTENTS

Section	Description	Page
1.	Getting Started	5
1.1	Important Safety Instructions	5
1.2	Setup	7
	Where to Place the Lifecycle® Exercise Bike // How to Stabilize the Lifecycle Exercise Bike // How to Adjust the Seat // How to Adjust the Pedal Straps // Starting Up the Bike Console // Using the Power Assist Option // Fitness and Entertainment Networking	
2.	The Display Console	10
2.1	The Display Console Overview	10
2.2	Display Console Descriptions	11
2.3	The Accessory Tray	14
3.	Heart Rate Zone Training Exercise	15
3.1	Why Heart Rate Zone Training Exercise?	15
3.2	Heart Rate Monitoring	16
	The Lifepulse™ Digital Heart Rate Monitoring System // The Polar® Telemetry Heart Rate Monitoring Chest Strap	
4.	The Workouts	18
4.1	Workout Overviews	18
4.2	Using the Workouts	19
	To Begin Any Workout // Selecting Quick Start // Selecting a Workout // Lifecycle Exercise Bike Workout Setup Steps (chart) // Entering Age // Entering Time // Selecting and Adjusting the Intensity Level // Selecting a Goal Type // Selecting a Workout Mode // Switching Workouts “On-the-Fly” // Pausing Workouts // Ending Workouts Early	
4.3	Workout Descriptions	24
	Quick Start // Fat Burn // Cardio // Hill // Random // Manual // Heart Rate Hill™ Workout // Heart Rate Interval™ Workout // Extreme Heart Rate™ Workout // Watts // METs // Aerobics Trainer // Personal Trainer Workout // Six Pre-Set Workouts // Fit Test // Military Fitness Test (when enabled)	
5.	Optional Settings	34
5.1	Entering and Using The Optional Settings Feature	34
5.2	About Personal Trainer Workouts	35
	To Create a Personal Trainer Workout	
6.	Service and Technical Data	36
6.1	Preventative Maintenance Tips	36
6.2	Preventative Maintenance Schedule	37
6.3	Troubleshooting the Polar Heart Rate Chest Strap	37
	Heart Rate Reading is Erratic or Absent Entirely // Heart Rate Reading is Erratic or Extremely High	
6.4	Troubleshooting the Lifepulse System Sensors	37
6.5	Recycling the Battery	38
6.6	How to Obtain Product Service	38
7.	Specifications	39
7.1	95Ci Lifecycle Exercise Bike Specifications	39

© 2003 Life Fitness®, a division of Brunswick Corporation. All rights reserved. Life Fitness, Life Cycle, and Zone Training are registered trademarks of Brunswick Corporation. Zone Training+, Heart Rate Hill, Heart Rate Interval, Extreme Heart Rate, and Lifepulse are trademarks of Brunswick Corporation. Polar is a registered trademark of Polar Electro, Inc. Cardio Theater is a registered trademark of the Cardio Theater Holdings. FitLinxx is a registered trademark of the Integrated Fitness Corp. Any use of these trademarks, without the express written consent of Life Fitness or the corresponding companies is forbidden.

This Operation Manual describes the functions of the following products:

Life Fitness Lifecycle® exercise bike:

95Ci

See Section 7, titled *Specifications*, in this manual for product-specific features.

Statement of Purpose: The Life Fitness Lifecycle exercise bike is a machine that simulates the movements of riding a bicycle at various speeds and levels of resistance.



Health-related injuries may result from incorrect or excessive use of exercise equipment. Life Fitness **STRONGLY** recommends seeing a physician for a complete medical exam before undertaking an exercise program, particularly if the user has a family history of high blood pressure or heart disease; or is over the age of 45; or smokes, has high cholesterol, is obese, or has not exercised regularly in the past year. Life Fitness also recommends consulting a fitness professional on the correct use of this product.

If, at any time while exercising, the user experiences faintness, dizziness, pain, or shortness of breath, he or she must stop immediately.



Des problèmes de santé peuvent être causés par une utilisation incorrecte ou excessive de l'équipement. Life Fitness conseille **VIVEMENT** de consulter un médecin pour subir un examen médical complet avant de commencer tout programme d'exercice, et tout particulièrement si l'utilisateur a des antécédents familiaux d'hypertension ou de troubles cardiaques, ou s'il a plus de 45 ans, s'il fume, s'il a du cholestérol, s'il est obèse ou n'a pas fait d'exercice régulièrement depuis un an. Life Fitness recommande également de consulter un professionnel du conditionnement physique pour savoir comment utiliser correctement ce produit.

Si, pendant l'utilisation de l'appareil, l'utilisateur ressent un malaise, des vertiges, des douleurs ou des difficultés à respirer, il doit s'arrêter immédiatement.

1 GETTING STARTED

1.1 IMPORTANT SAFETY INSTRUCTIONS



SAFETY WARNING: The safety of the product can be maintained only if it is examined regularly for damage and wear. See Preventative Maintenance section for details.

- Use the Life Fitness Lifecycle exercise bike only as directed in this manual.
- If a Lifecycle exercise bike does not function properly after it has been dropped, damaged, or even partially immersed in water, contact Life Fitness Customer Support Services for assistance.
- Do not allow other people to interfere in any way with the user or equipment during a workout.
- Always follow the console instructions for proper operation.
- Supervise closely any children or disabled persons using the Lifecycle exercise bike.
- Do not use the Lifecycle exercise bike outdoors, near swimming pools, or in areas of high humidity.
- Never insert objects into any opening of the Lifecycle exercise bike. If an object should drop inside, carefully retrieve it while the unit is not in use. If the object cannot be reached, contact Life Fitness Customer Support Services.
- Never place containers filled with liquids directly on the unit, except in the accessory tray water bottle holder. Containers should be covered with lids.
- Wear shoes with rubber or high-traction soles. Do not use shoes with heels, leather soles, cleats, or spikes. Make sure no stones are embedded in the soles.
- Do not use the Lifecycle exercise bike with bare feet.
- Keep all loose clothing, shoelaces, and towels away from moving parts.
- Do not reach into, or underneath, the unit; and do not tip the unit on its side during operation.
- Keep the area around the Lifecycle exercise bike clear of any obstructions, including walls and furniture. Provide at least three feet of clearance behind the unit.
- Use caution when stepping on or off of the Lifecycle exercise bike.
- Never face backward while using the Lifecycle exercise bike.

SAVE THESE INSTRUCTIONS FOR FUTURE REFERENCE.

1 POINT DE DÉPART

1.1 CONSIGNES DE SÉCURITÉ IMPORTANTES



CONSIGNE DE SÉCURITÉ : pour un emploi sûr, le produit doit être inspecté régulièrement afin de s'assurer qu'il n'est pas usé ni endommagé. Consultez la section de Maintenance préventive pour obtenir de plus amples informations.

- Si un vélo d'exercice Life Cycle ne fonctionne pas correctement après avoir subi une chute, des dommages ou une immersion même partielle dans l'eau, contactez le service d'assistance clientèle de Life Fitness.
- Pour un fonctionnement correct, suivez toujours les instructions de la console.
- Une surveillance étroite est nécessaire en cas d'utilisation par des enfants, des personnes invalides ou handicapées.
- N'utilisez pas ce produit à l'extérieur, près d'une piscine ou dans endroits très humides.
- Ne faites jamais fonctionner de produit Life Fitness dont les bouches d'aération seraient bloquées. Maintenez-les exemptes de peluches, de cheveux ou de toute obstruction.
- N'insérez jamais d'objet dans les ouvertures de cet appareil. Si un objet tombe dedans, coupez l'alimentation électrique, débranchez le cordon de la prise et récupérez-le avec précaution. Si vous ne pouvez pas l'atteindre, consultez le service après-vente de Life Fitness.
- Ne placez jamais de liquides d'aucune sorte directement sur l'appareil, sauf si vous disposez d'un support ou d'un plateau pour accessoires. Il est recommandé d'utiliser des conteneurs munis d'un couvercle.
- Portez des chaussures avec semelles en caoutchouc ou antidérapantes. N'utilisez pas de chaussures à talons, de semelles en cuir ou à crampons. Assurez-vous qu'aucun caillou ne s'est incrusté dans les semelles.
- Maintenez les vêtements lâches, les lacets et les serviettes à l'écart des pièces en mouvement.
- N'utilisez pas cet appareil sans chaussures.
- Ne faites pas basculer l'appareil sur le côté tandis qu'il fonctionne.
- Maintenez la zone autour du produit Life Fitness exempte d'obstructions, y compris de murs et de meubles. Veillez à laisser au moins 30 cm d'espace autour du Lifecycle exercise bike.
- Procédez avec précaution lors du montage ou du démontage de la machine. Utilisez la barre fixe pour renforcer votre stabilité. Pendant les exercices, saisissez les bras mobiles.
- N'utilisez jamais cet appareil en vous tournant vers l'arrière.

CONSERVEZ CES INSTRUCTIONS POUR USAGE ULTÉRIEUR.

1.2 SETUP

Read the entire Operation Manual before setting up the Lifecycle exercise bike.

WHERE TO PLACE THE LIFECYCLE® EXERCISE BIKE

Following all safety instructions in Section 1.1, move the bike to the location in which it will be used. See Section 7, titled *Specifications*, for the dimensions of the footprint. Allow a distance of 8 to 12 inches, or 21 to 30 centimeters, between the bike and other objects or surfaces on either side. Allow a distance of 3 feet, or 1 meter, from the front or rear of the bike to any other object or surface.

HOW TO STABILIZE THE LIFECYCLE EXERCISE BIKE

After placing the bike in position, check the unit's stability by attempting to rock it from side to side. Any slight rocking indicates that the unit must be leveled. Determine which foot is not resting completely on the floor. Loosen the jam nut with an open-end 9/16-inch wrench, and rotate the stabilizing foot to lower it. Verify that the bike is stable, and repeat the adjustment as necessary until the unit no longer rocks. Lock the adjustment by tightening the jam nut against the stabilizer bar.

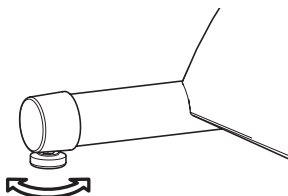

HOW TO ADJUST THE SEAT

It is important to adjust the seat to an optimal height for pedaling on the Lifecycle exercise bike. Pedaling with the seat too low can place excessive strain on the knees and quadriceps muscles. Pedaling with the seat too high can irritate the feet, ankles, hips, and knees. To determine whether or not the seat requires adjustment, sit on it and place the balls of the feet on the pedals. The knee should bend slightly when the pedal is at the lowest point of its rotation. It should be possible to pedal without locking the knees or shifting in the seat.

The bike features a vertical ratchet seat adjustment system, which makes it easy and safe to change the height of the seat quickly. To raise the seat, either lift the body so that there is no weight on the seat, or get off the bike. Then, simply pull the seat upward to the desired height, and let it lock into place. Test and re-adjust the seat height as necessary.

To lower the seat, first get off the bike. Holding the seat, pull up the adjustment lever in front of the seat post to unlock the post, let the seat slide down to the desired height, and release the lever to lock the post into place. Test and re-adjust the seat height as necessary.



CAUTION: When using the height adjustment mechanism to change the height of a partially raised seat, hold the seat to prevent it from falling on the hand.



MISE EN GARDE - Lorsque vous utilisez le mécanisme de réglage de la hauteur pour monter une selle déjà partiellement surélevée, maintenez cette dernière afin qu'elle ne vous tombe pas sur la main.

The bike's seat post can be adjusted in half-inch increments within a 13-inch range. A total of 26 height settings are possible.

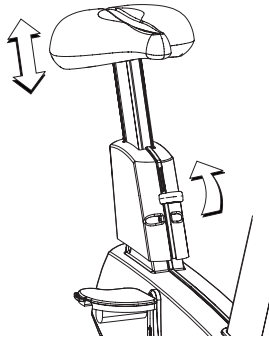

HOW TO ADJUST THE PEDAL STRAPS

The bike pedal straps keep the user's shoes on the pedals during a workout. The straps should fit comfortably, but they also should be tight enough to prevent shoes from slipping at any point in the pedaling rotation. Before working out, a user should test and adjust the tightness of the straps.

The safety straps on the foot pedals of the Lifecycle exercise bike can be adjusted to fit a variety of shoe sizes. The straps are held in place by two knobs that extend from either side of each pedal. The "inner" knob extends sideways, that is, toward the bike. The "outer" knob extends downward. The ends of each strap are perforated with slots that fit tightly over the knobs. The "inner" end of each strap is perforated with two slots, and the "outer" segment of the strap is perforated with a row of slots.

To tighten or loosen a strap, grasp the outer end, and pull it back, away from the knob, until the strap slides off. Pull the strap out through the outer loop on the pedal. Rest the foot on the pedal, and wrap the strap over the foot to determine the desired length. Thread the strap through the outer loop on the pedal, tuck it under the pedal, select the appropriate slot, and pull that slot down over the knob, until the top of the knob pops through the slot. A click indicates that the strap is locked into place.

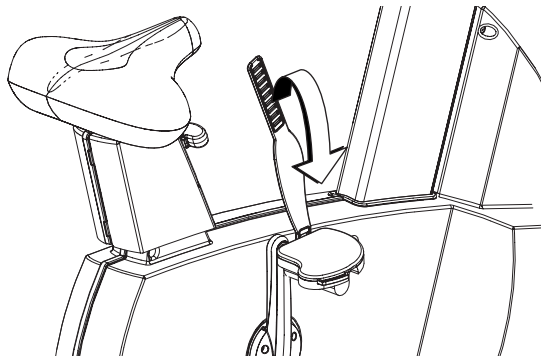

STARTING UP THE BIKE CONSOLE

When a user begins pedaling on the Lifecycle exercise bike, the unit's Auto-Start feature powers up the console, causing the console display to light up and the MESSAGE CENTER to flash a prompt: "SELECT WORKOUT OR PRESS QUICK START." If the user does not make a selection in 20 seconds, the console automatically starts a **MANUAL** workout. For information on setting up a workout, see Section 4.2, titled *Using the Workouts*. If the user stops pedaling for more than 15 seconds, the console shuts down.

Alternately, the user may begin pedaling at a predetermined rate and press the START key to power up the console.

USING THE POWER ASSIST OPTION

The Lifecycle exercise bike's optional Power Assist feature makes it possible for the console to be powered by an external electrical source, eliminating the need to pedal at a minimum speed to supply constant power to the console. With this option, users who wish to ride the bike for rehabilitative exercise may pedal at a rate below the minimum without losing console power.

Enabling the Power Assist option requires a an optional kit. To order the kit, contact Life Fitness Customer Service. See section 6.5, titled *How to Obtain Product Service*, for more information.

The connector plugs into the bike at the front of the frame, near the base.

FITNESS AND ENTERTAINMENT NETWORKING

Two interchangeable network ports allow the Lifecycle exercise bike to be connected to a fitness entertainment system and/or a network, such as FitLinxx® interactive fitness network.

- **Fitness network:** The network connection enables the console to upload user workout statistics to a fitness network database or to download remotely stored information, such a pre-set workout program. See Section 4.2, titled *Using the Workouts*, for information on logging onto a network.
- **Entertainment:** The network connection enables the console to power a third-party receiver for use with a service such as the Cardio Theater® entertainment system or the BroadcastVision™ entertainment system.

These ports are located on the back of the bike console and are enclosed by a removable cover. Any use of the ports for other than their intended purpose could void the product warranty.

2 THE DISPLAY CONSOLE

2.1 DISPLAY CONSOLE OVERVIEW

The computerized display console on the Lifecycle exercise bike allows the user to tailor a workout to personal fitness abilities and goals and to monitor progress. With this easy-to-use console, the user can track fitness improvement from one workout to the next.

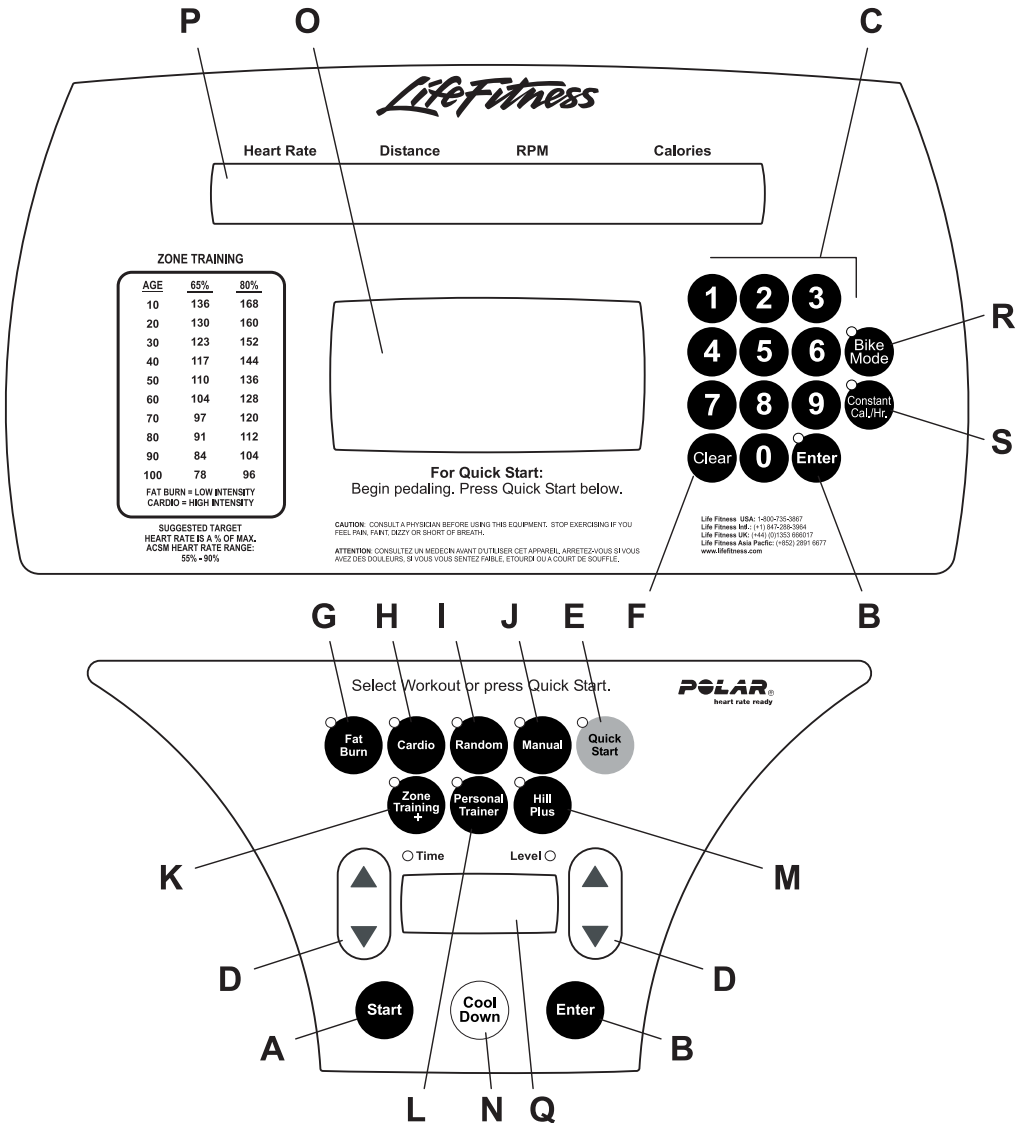

2.2 DISPLAY CONSOLE DESCRIPTIONS

This section lists and describes the functions for the keys and display windows on the Lifecycle exercise bike console. See Section 4, titled *The Workouts*, for detailed information on using the console to set up workouts.

A START: Press this key to activate the console for programming a new workout. The activated console lights up and displays **SELECT WORKOUT OR PRESS QUICK START**. If no key is pressed for 15 seconds, the console shuts down again.

NOTE: The bike's AutoStart feature also activates the console when the user steps on the pedals. See the topic titled Starting Up the Bike Console, which appears in Section 1.

B ENTER: Press this key after entering each value, such as weight or workout time, when prompted by console display messages.

C NUMERIC keypad: Use these keys to enter values, such as length of workout, weight, age, target heart rate, and intensity level. While a workout is in progress, numeric keys can be used to set new intensity levels or change the target heart rate in a **FAT BURN, CARDIO, HEART RATE HILL, HEART RATE INTERVAL**, and **EXTREME HEART RATE** workout. The **ARROW** keys have a similar function, except that they change workout parameters by single increments.

D ARROW keys: A pair of **UP** and **DOWN** arrows is located on either side of the **TIME/LEVEL WINDOW**. Use either set of arrows, when setting up a workout, to change workout parameters displayed on the console, such as length of workout, weight, age, target heart rate, and intensity level. During a workout, pressing the arrows on the **LEVEL** side of display changes intensity levels. Pressing the arrows on the **TIME** side lengthens or decreases the workout duration.

E QUICK START: Press this key to begin a manual workout immediately, without having to select a workout program. Once the workout is in progress, use the **ARROW** keys or the **NUMERIC** keypad to change the intensity level or workout duration as desired.

F CLEAR: Press this key, when programming a workout, to clear incorrect data, such as weight or age, before pressing the **ENTER** key. Pressing **CLEAR** during a workout stops it immediately, at which point, the **MESSAGE CENTER** displays a summary of the workout, including total time elapsed, total distance traveled, and total calories burned. Pressing **CLEAR** a second time causes the **MESSAGE CENTER** to prompt the user for a new workout setup.

G FAT BURN: Press this key to select the **FAT BURN** program, which is a low-intensity workout for burning fat.

H CARDIO: Press this key to select the **CARDIO** program, which is a higher intensity workout for more fit users, emphasizing cardiovascular benefits and maximum fat burning.

I RANDOM: Press this key to select the **RANDOM** program, which is a workout of constantly changing intensity levels that occur in no regular pattern or progression.

J MANUAL: Press this key to select the **MANUAL** program, in which the intensity level remains the same unless it is manually changed.

- K ZONE TRAINING+:** Press this key to select one of the workouts that target specific ranges, or zones, for maintaining a heart rate to achieve maximum exercise results. The following options may be accessed with this key:
- **HEART RATE HILL**
 - **HEART RATE INTERVAL**
 - **EXTREME HEART RATE**
 - **TIME IN ZONE GOAL**
 - **FAT BURN** (also accessible with FAT BURN key)
 - **CARDIO** (also accessible with CARDIO key)
- L PERSONAL TRAINER:** Press this key for additional workout options, including customized workouts designed by a fitness club trainer or staff member. See Section 5, titled *Optional Settings* for information on designing **PERSONAL TRAINER** custom workouts. The following workouts and goals may be accessed with this key:
- **METS** (when enabled)
 - **WATTS** (when enabled)
 - **AEROBICS TRAINER**
 - **FIT TEST**
 - **PERSONAL TRAINER WORKOUTS**
 - **CALORIE GOAL**
 - **DISTANCE GOAL**
 - **AIR FORCE PRT** (when enabled)
- M HILL PLUS:** Press this key to select **HILL PLUS** workouts, in which intensity levels increase and decrease in set patterns. The following workouts may be accessed with this key:
- **HILL**
 - **AROUND THE WORLD**
 - **KILIMANJARO**
 - **INTERVAL**
 - **CASCADES**
 - **SPEED TRAINING**
 - **FOOT HILLS**
- N COOL DOWN:** Workout programs end automatically in a Cool Down mode, which lowers the intensity level. In this phase of a workout the body begins to remove lactic acid and other accumulated by-products of exercise, which build up in muscles during a workout and contribute to muscle soreness. Press the COOL DOWN key at any desired point during a workout to go immediately into Cool Down mode. The console automatically adjusts each workout's Cool Down level according to the individual user's performance.
- O WORKOUT PROFILE window:** This window displays shapes, made of columns of lights, that represent the levels of intensity in a workout-in-progress. The height of the column furthest to the left is proportional to the current level of the intensity.

During a **FAT BURN, CARDIO, HEART RATE HILL, HEART RATE INTERVAL, or EXTREME HEART RATE** workout, which requires the use of a Polar heart rate chest strap or the Lifepulse system sensors, the WORKOUT PROFILE window displays a flashing heart shape to request the user's heart rate signal. If the console does not detect a signal, the MESSAGE CENTER displays the prompt, "NEED HEART RATE - PLACE HANDS ON SENSORS OR USE TELEMETRY STRAP". If the console does not receive the signal within three minutes, the workout automatically is converted to a **MANUAL** program.

- P MESSAGE CENTER:** This window displays step-by-step instructions for setting up a workout. During a workout, it displays statistics about the progress of the workout:
- **Heart Rate:** the detected heart rate if the user is wearing the Polar heart rate chest strap or grasping the Lifepulse system sensors.
 - **Distance:** the total distance traveled.
 - **RPM (Revolutions Per Minute):** the pedaling speed or rate.
 - **Calories:** the number of calories burned since beginning the workout.

If programmed to do so, the MESSAGE CENTER displays other values each time the intensity level changes during the workout:

- **Calories per Hour:** the rate of calories burned per hour.

OR

- **Watts:** effort level in Watts. The Watt is a unit of power output or the expression of the mechanical rate of work.
- **METs:** effort level in METs. The MET is an expression of the rate of work for the human body at rest, or a metabolic equivalent; one MET is approximately equal to the metabolism of a person at rest.

See Section 5, titled *Optional Settings* for information about enabling the MESSAGE CENTER to display these additional settings.

- Q LEVEL/TIME WINDOW:** This window displays the programmed intensity level and the time elapsed since the start of the program.
- R BIKE MODE:** Press this key to activate the Bike workout mode in which the rate of calories burned and the total distance travelled increase automatically as the user increases the pedaling speed.
- S CONSTANT CAL./HOUR:** Press this key to activate this alternate workout mode, which enables a user to maintain a consistent rate of calories burned per hour.

For more information about Bike Mode and Constant Calories Per Hour Mode, see the topic *Selecting a Workout Mode* in Section 4.2, titled, the *Using the Workouts*.

2.3 THE ACCESSORY TRAY

The accessory tray (A), which is mounted near the base of the console, provides dual storage trays with space for items such as water bottles, personal stereos, and cell phones. Additionally, an integrated reading rack for supporting a book or magazine (B) is located at the base of the upper panel of the console.

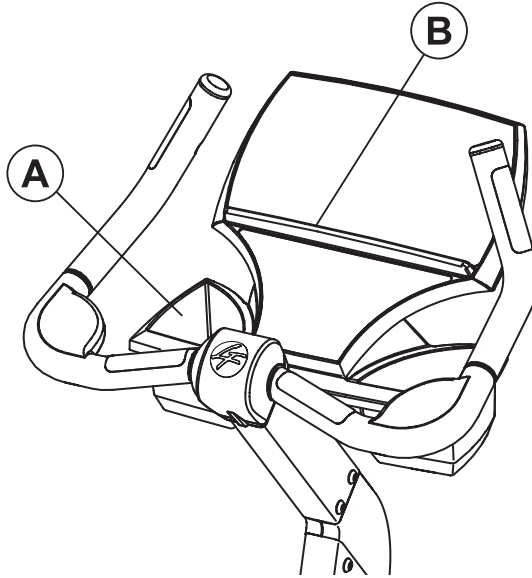

3 HEART RATE ZONE TRAINING EXERCISE

3.1 WHY HEART RATE ZONE TRAINING EXERCISE?

Research shows that maintaining a specific heart rate while exercising is the optimal way to monitor the intensity of a workout and to achieve maximum results. That is the idea behind the Life Fitness heart rate zone training approach to exercise.

Zone Training identifies an exerciser's ideal heart rate range, or zone, for burning fat or increasing cardiovascular fitness. The values within the zone depend on the workout.

NOTE: Consulting a fitness trainer is recommended for defining specific fitness goals and designing a workout program.

ZONE TRAINING		
FAT BURN = LOW INTENSITY		
CARDIO = HIGH INTENSITY		
AGE	65%	80%
10	136	168
20	130	160
30	123	152
40	117	144
50	110	136
60	104	128
70	97	120
80	91	112
90	84	104
100	78	96

SUGGESTED TARGET
HEART RATE AS % OF MAX
ACSM HEART RATE RANGE:
55% - 90%

The Lifecycle exercise bike features five exclusive workouts designed to take full advantage of the benefits of heart rate zone training exercise: **FAT BURN**, **CARDIO**, **HEART RATE HILL**, **HEART RATE INTERVAL**, and **EXTREME HEART RATE**. The Time in Zone Goal option, another feature of heart rate zone training, enhances these workouts by setting a certain duration within the target zone as a workout goal. For detailed information about the workouts, as well as the Time In Zone Goal option, see Section 4, titled *The Workouts*.

During one of these workouts, grasp the Lifepulse system sensors, or wear the Polar heart rate chest strap to enable the bike's on-board computer to monitor the heart rate. The computer automatically adjusts the resistance level to maintain the target heart rate based on the actual heart rate. To change the target heart rate during a workout, switch between these programs, or simply enter a new target heart rate, using the NUMERIC keypad.

3.2 HEART RATE MONITORING

THE LIFEPULSE™ DIGITAL HEART RATE MONITORING SYSTEM

The patented Lifepulse system sensors are the built-in heart rate monitoring system on the Life Fitness Lifecycle exercise bike. During a workout, grasp two of the four sensors (A and B) that are set into the handlebars. For an accurate reading, use a comfortable grip. The console displays the heart rate after 10 to 40 seconds.

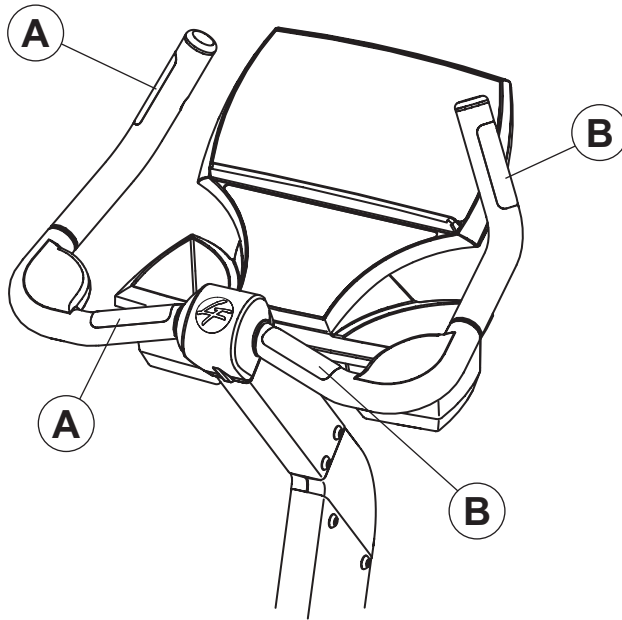

THE POLAR® TELEMETRY HEART RATE MONITORING CHEST STRAP

The Lifecycle exercise bike is equipped with Polar telemetry, a heart rate monitoring system in which electrodes, pressed against the skin, transfer heart rate signals to the bike console. These electrodes are attached to a chest strap that the user wears during the workout. The chest strap is optional. To order it, call Life Fitness Customer Support Services. See Section 6.5, titled *How to Obtain Product Service*.

See the diagram below for correct positioning of the strap. The electrodes (A), which are the two grooved surfaces on the underside of the strap, must remain wet to transmit accurately the electrical impulses of the heart back to the receiver. Moisten the electrodes. Then, secure the strap as high under the chest muscles as possible. The strap should be snug, but comfortable enough to allow for normal breathing.

The transmitter strap delivers an optimal heart rate reading when the electrodes are in direct contact with skin. However, it also functions properly through a thin layer of wet clothing.

If it becomes necessary to re-moisten the chest strap electrodes, grasp the center of the strap, pull it away from the chest to expose the two electrodes, and moisten them.

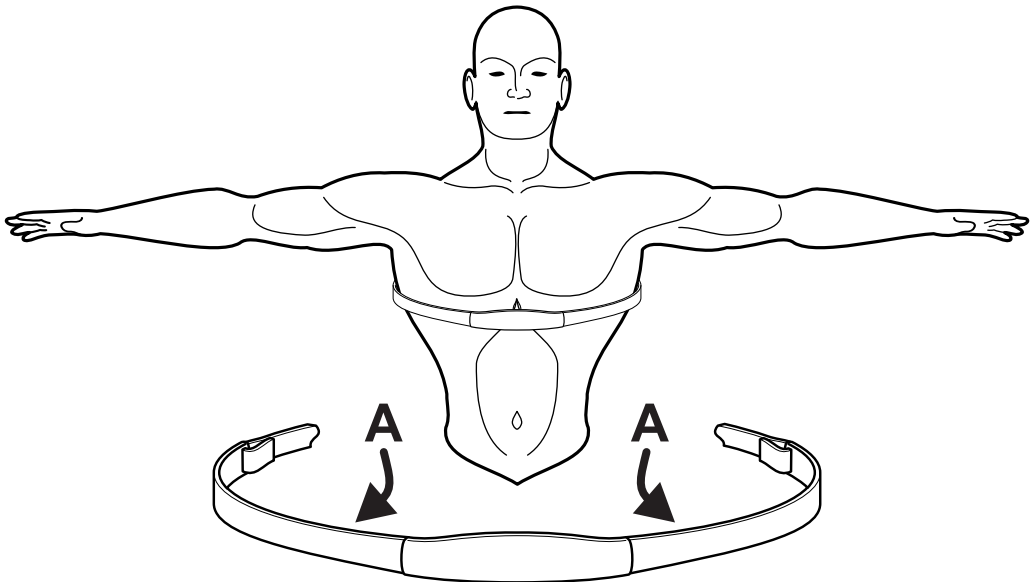

4 THE WORKOUTS

4.1 WORKOUT OVERVIEWS

This section lists the Lifecycle exercise bike's pre-programmed workouts. For more detailed information, see Section 4.2, titled *Using the Workouts*.

QUICK START is the fastest way to begin exercising, and it bypasses the steps involved in selecting a specific workout program. After the QUICK START key is pressed, a constant-level workout begins. The intensity level does not change automatically.

RANDOM is an interval training workout of constantly changing intensity levels that occur in no regular pattern or progression.

MANUAL is a workout in which the intensity level does not change automatically.

FAT BURN is a low-intensity workout for burning the body's fat reserves. The user must wear a Polar heart rate chest strap, or grasp the Lifepulse system sensors continuously. The workout program automatically adjusts the intensity level, based on the actual heart rate, to maintain the rate at 65 percent of the theoretical maximum[†].

CARDIO is a higher intensity workout for more fit users, emphasizing cardiovascular benefits and maximum fat burning. The user must wear a Polar heart rate chest strap, or grasp the Lifepulse system sensors continuously. The workout program automatically adjusts the intensity level, based on the actual heart rate, to maintain the rate at 80 percent of the theoretical maximum.

The following three workouts are accessed by pressing the ZONE TRAINING+ key :

HEART RATE HILL™ takes the user through three different hills based on the target heart rate*. The user wears a heart rate chest strap, or grasps the Lifepulse™ sensors continuously.

HEART RATE INTERVAL™ alternates between a hill and a valley based on the target heart rate*. The user wears a heart rate chest strap, or grasps the Lifepulse™ sensors continuously.

EXTREME HEART RATE™ is an intense workout for more experienced users. It is designed to get the heart rate up and down as quickly as possible. The user wears a heart rate chest strap, or grasps the Lifepulse™ sensors continuously.

The following seven workouts are accessed by pressing the HILL PLUS key :

HILL is an interval-training workout combining "hills" and "valleys" of different intensity levels, which is proven to provide effective, time-efficient cardiovascular results.

AROUND THE WORLD is an interval-training workout in which the hills resemble scenes of various geographical areas.

FOOT HILLS is a rolling hill workout with low intensity levels.

[†] Defined by the American College of Sports Medicine's "Guidelines for Exercise Testing and Prescription" as equal to 220 minus an individual's age.

* Target Heart Rate (THR) is a percentage of the theoretical maximum. For example, a 40-year-old user's THR for the **HEART RATE HILL** workout is 144. This workout targets 80 percent of the maximum, so the equation would be $(220-40) \cdot 80 = 144$.

KILIMANJARO is a Hill workout in which the intensity levels gradually incline toward one ultimate peak and then gradually decline.

INTERVAL is a Hill workout in which intensity levels rise and fall. The higher levels gradually incline toward a peak and then gradually decline.

CASCADES is a two-peak workout in which intensity levels gradually increase and decrease.

SPEED TRAINING is a Hill workout in which the intensity level alternates between high and low levels very quickly to simulate a typical speed-training workout.

The following workouts are accessed by pressing the PERSONAL TRAINER key :

PERSONAL TRAINER WORKOUTS can be created by authorized personal. See Section 5.2, titled *About Personal Trainer Workouts*.

FIT TEST measures cardiovascular fitness compared to other people of the same age and gender.

MILITARY FITNESS TEST is similar to the FIT TEST workout, except that this program is based upon a specific predefined protocol. The available test is:

- **AIR FORCE PHYSICAL READINESS TEST (PRT) - (U.S. MILITARY)**

WATTS targets a rate of effort equal to a certain number of Watts. By default, this workout is turned off. For information on making it available, see Section 5, titled *Optional Settings*.

METs targets a rate of effort equal to a certain number of METs. By default, this workout is turned off. For information on making it available, see Section 5, titled *Optional Settings*.

AEROBICS TRAINER is a workout in which the MESSAGE CENTER prompts the user to switch continuously between a high and low pedaling speeds. The speed intervals alternate in a pattern that promotes a build-up in the intensity of the workout, followed by a build-down in intensity.

4.2 USING THE WORKOUTS

Different bike workouts require different setup steps. See the chart, titled *Lifecycle Exercise Bike Workout Set-up Steps* for a quick glance at the steps for setting up any workout program. This section provides details on the steps themselves.

TO BEGIN ANY WORKOUT

Without networking, start pedaling and press START, or simply start pedaling to activate the console. The MESSAGE CENTER displays the prompt: "SELECT WORKOUT OR PRESS QUICK START". If it displays a different message, press the CLEAR key twice rapidly.

With optional networking enabled, start pedaling, and press START or simply start pedaling to activate the console. The MESSAGE CENTER displays the prompt: "SELECT WORKOUT OR ENTER ID USING ENTER KEY". Select a workout, or log on to the networked exercise database, download the preset workout.

To log onto the network, press ENTER, and key in the user ID number with the NUMERIC KEYPAD.

SELECTING AND USING QUICK START

QUICK START is the fastest way to begin exercising, and it bypasses the steps of selecting a specific workout program. At the MESSAGE CENTER prompt to select a workout, press the QUICK START key. The workout begins at an intensity level that remains the same unless manually changed.

SELECTING A WORKOUT

For **MANUAL**, **FAT BURN**, **CARDIO**, and **RANDOM**: When prompted to select a workout, press the key labeled with the name of the desired workout.

For **HEART RATE HILL**, **HEART RATE INTERVAL**, and **EXTREME HEART RATE**: When prompted by the MESSAGE CENTER to select a workout, press the ZONE TRAINING+ key. The MESSAGE CENTER then displays the name of one of these workouts. Press ENTER to select the displayed workout; or continue to press the ZONE TRAINING+ key to display each of the other options, and then press ENTER to select the desired workout.

LIFECYCLE EXERCISE BIKE WORKOUT SETUP STEPS

QUICK START

Press QUICK START
Begin workout

RANDOM

Press RANDOM
Enter time
Select level
Begin workout

MANUAL

Press MANUAL
Enter time
Select level
Begin workout

HILL

Press HILL PLUS; when
HILL appears, press
ENTER
Enter time
Select level
Begin workout

FAT BURN*

Press FAT BURN
Enter time
Enter age
Accept THR**
Begin workout

CARDIO*

Press CARDIO
Enter time
Enter age
Accept THR
Begin workout

HEART RATE HILL*

Press ZONE TRAINING+
repeatedly until HR HILL
appears; press ENTER
Enter time
Enter age
Accept THR
Begin workout

HEART RATE INTERVAL*

Press ZONE TRAINING+
repeatedly until HR
INTERVAL appears;
press ENTER
Enter time
Enter age
Accept THR
Begin workout

EXTREME HEART RATE*

Press ZONE TRAINING+
repeatedly until
EXTREME HR appears;
press ENTER
Enter time
Enter age
Accept THR
Begin workout

WATTS

Press PERSONAL
TRAINER repeatedly
until WATTS appears;
press ENTER
Enter time
Enter Watts goal value
Begin workout

METS

Press PERSONAL
TRAINER repeatedly
until METS appears;
press ENTER
Enter time
Enter METS goal value
Begin workout

AROUND THE WORLD

Press HILL PLUS repeat-
edly until AROUND THE
WORLD Appears; press
ENTER
Enter time
Select level
Begin workout

KILIMANJARO

Press HILL PLUS repeat-
edly until KILIMAN-
JARO appears; press
ENTER
Enter time
Select level
Begin workout

INTERVAL

Press HILL PLUS repeat-
edly until INTERVAL
appears; press ENTER
Enter time
Select level
Begin workout

CASCADES

Press HILL PLUS repeat-
edly until
CASCADES appears;
press ENTER
Enter time
Select level
Begin workout

SPEED TRAINING

Press HILL PLUS repeat-
edly until SPEED
TRAINING appears;
press ENTER
Enter time
Select level
Begin workout

FOOT HILLS

Press HILL PLUS repeat-
edly until FOOT HILLS
appears; press ENTER
Enter time
Select level
Begin workout

PERSONAL TRAINER WORKOUTS

Press PERSONAL
TRAINER repeatedly
until PERSONAL
TRAINER appears;
press ENTER
Select the desired
workout number, from
1 to 6; press ENTER
Begin workout

AEROBICS TRAINER

Press PERSONAL
TRAINER repeatedly
until AEROBICS
TRAINER appears;
press ENTER
Enter time
Select level
Begin workout

FIT TEST**

Press PERSONAL
TRAINER repeatedly
until FIT TEST
appears;
press ENTER
Enter weight
Enter age
Enter gender
Enter level
Begin workout

AIR FORCE PRT

Press PERSONAL
TRAINER repeatedly
until AIR FORCE PRT
appears; press ENTER
Enter weight
Enter height
Enter age
Enter gender
Answer prompt
Begin workout

* This workout requires the user to wear the polar heart rate chest strap or to grip the Life pulse sensors.

** Target Heart Rate (THR) is a percentage of the theoretical maximum. A 40-year-old user's THR for the **FAT BURN** workout is 117. This workout targets 65 percent of the maximum, so the equation would be $(220-40) \cdot 65 = 117$.

For **WATTS, METS, CALORIE GOAL, DISTANCE GOAL, AEROBICS TRAINER, FIT TEST, MILITARY FITNESS TEST**, and **PERSONAL TRAINER WORKOUTS**: When prompted by the MESSAGE CENTER to select a workout, press the PERSONAL TRAINER key. The MESSAGE CENTER displays the name of a workout. Press ENTER to select the displayed workout; or continue to press the PERSONAL TRAINER key to display each of the other options. Press ENTER to select the desired workout.

For **HILL, AROUND THE WORLD, KILIMANJARO, INTERVAL, CASCADES, SPEED TRAINING**, and **FOOT HILLS**: When prompted by the MESSAGE CENTER to select a workout, press the HILL PLUS key. The MESSAGE CENTER then displays the name of the one of these workouts. Press ENTER to select the displayed workout; or continue to press the HILL PLUS key to display each of the other options, and then press ENTER to select the desired program.

ENTERING AGE

When prompted by the MESSAGE CENTER to enter age, use the ARROW KEYS to increase or decrease the displayed age to the correct value, or key in the correct value with the NUMERIC KEYPAD, and press ENTER.

Lifecycle exercise bike workout programs that set a target heart rate zone first calculate the user's theoretical maximum heart rate[†] by subtracting the user's age from the number 220. The programs then calculate the target zone as a percentage of the theoretical maximum.

ENTERING TIME

When prompted by the MESSAGE CENTER to enter a time, use the ARROW KEYS to increase or decrease the displayed time to the desired value, or key in the desired value with the NUMERIC KEYPAD, and press ENTER.

SELECTING AND ADJUSTING THE INTENSITY LEVEL

When prompted by the MESSAGE CENTER, use the ARROW keys to increase or decrease the displayed intensity level or target heart rate* to the desired value, or key in the desired value with the NUMERIC KEYPAD, and press ENTER. Adjust the level as needed or desired during the workout.

- Intensity level: The Lifecycle exercise bike provides a selection of 25 intensity levels. The intensity level appears in the WORKOUT PROFILE window as rows of lights arranged in columns. Selecting a low intensity level at first is recommended. As physical conditioning improves, the levels can increase.
- Target heart rate: Programs that calculate a target heart rate base this number on the age of the user and the type of workout. The user accepts or adjusts the rate when setting up the workout. During the workout itself, the program reads the heart rate, which is transmitted via the Polar heart rate chest strap or the Lifepulse system sensors; and it uses this data to adjust the resistance. Manually raising the rate increases the intensity of the cardiovascular exercise.

[†] Defined by the American College of Sports Medicine's "Guidelines for Exercise Testing and Prescription" as equal to 220 minus an individual's age.

* Target Heart Rate (THR) is a percentage of the theoretical maximum. For example, a 40-year-old user's THR for the **CARDIO** workout is 144. This workout targets 80 percent of the maximum, so the equation would be $(220-40) \times .80 = 144$.

SELECTING A GOAL TYPE

Workouts can be programmed to target certain type of goals:

- Calories
- Distance
- Time in zone

The **Calories Goal** feature is designed to promote weight loss and weight control. The user sets a calorie goal during the workout setup. Once the goal is met, the workout automatically goes into a cool-down phase and ends afterward. To use this feature:

1. Press the the **PERSONAL TRAINER** key when prompted to select a workout.
2. Continue to press the **PERSONAL TRAINER** key until the **MESSAGE CENTER** displays “**CALORIES GOAL**”.
3. Press **ENTER**.
4. Enter the desired calorie goal value.
5. Select either the **RANDOM**, **MANUAL**, or **HILL** workout.
6. Run through the set-up steps for the selected workout.
7. Begin the workout.

The **Distance Goal** feature is designed to build endurance. The user sets a distance goal during the workout setup. Once the goal is met, the workout automatically goes into a cool-down phase and ends afterward. To use this feature:

1. Press the the **PERSONAL TRAINER** key when prompted to select a workout.
2. Continue to press the **PERSONAL TRAINER** key until the **MESSAGE CENTER** displays “**DISTANCE GOAL**”.
3. Press **ENTER**.
4. Enter the desired distance goal value.
5. Select either the **RANDOM**, **MANUAL**, or **HILL** workout.
6. Run through the setup steps for the selected workout.
7. Begin the workout.

The **Time in Zone Goal** program enhances **FAT BURN**, **CARDIO**, **HEART RATE HILL**, **HEART RATE INTERVAL**, and **EXTREME HEART RATE** workouts by setting a certain duration within the target zone* as a workout goal. The program automatically alters the resistance to maintain a pace that will meet that objective within that duration. Once the objective is met, the workout automatically goes into a cool-down phase. To use the Time In Zone Goal feature:

1. Press the **ZONE TRAINING+** key when prompted to select a workout
2. Continue to press the **ZONE TRAINING+** key until the **MESSAGE CENTER** displays “**TIME IN ZONE GOAL**”.
3. Press **ENTER**.
4. Select the duration for staying within the zone.

* Target Heart Rate (THR) is a percentage of the theoretical maximum. For example, a 40-year-old user's THR for the **FAT BURN** workout is 117. This workout targets 65 percent of the maximum, so the equation would be $(220-40) \cdot .65 = 117$.

5. Select a **FAT BURN, CARDIO, HEART RATE HILL, HEART RATE INTERVAL**, or **EXTREME HEART RATE** workout.
6. Enter age.
7. Accept or change the target heart rate* displayed by the MESSAGE CENTER.
8. Begin the workout.

SELECTING A WORKOUT MODE

Two workout mode options on the Lifecycle exercise bike feature alternate ways to vary workouts.

- **Bike Mode:** This workout mode simulates the experience of riding a real bicycle. The rate of calories burned and total distance travelled increase automatically as the user increases the pedaling speed. This mode can be used with all workouts, except for **FAT BURN, CARDIO, HEART RATE HILL, HEART RATE INTERVAL**, and **EXTREME HEART RATE**. To select Bike mode, press BIKE MODE key.
- **Constant-Calories-Per-Hour Mode:** This workout mode enables a user to maintain a consistent rate of calories burned per hour. As the pedaling speed increases, the resistance level automatically decreases. As the pedaling speed decreases, the resistance level automatically increases. This mode can be used with all workouts. To select it, press the CONSTANT CAL./HR. key.

If the user selects a **FAT BURN, CARDIO, HEART RATE HILL, HEART RATE INTERVAL**, or **EXTREME HEART RATE** workout during the setup, the default mode is Constant-Calories-Per-Hour. For all other workouts, the default mode is Bike. The user may select or change a mode during a workout setup or during a workout.

SWITCHING WORKOUTS “ON-THE-FLY”

It is possible, during a workout, to switch to another workout program. After a switch, the console retains all the progress information about the workout since its beginning. To change workouts “on the fly,” simply press the key for the desired new workout.

PAUSING WORKOUTS

To pause a workout, simply stop pedaling. To continue the workout, resume pedaling. The pause duration lasts 60 seconds, after which, the console automatically shuts down.

ENDING WORKOUTS EARLY

To end a workout before the pre-set duration expires, press CLEAR once. The MESSAGE CENTER then displays a workout summary, which includes the distance travelled, the total calories burned, and other statistics. Press CLEAR a second time, and the MESSAGE CENTER displays “SELECT WORKOUT OR PRESS QUICK START” for a new workout.

4.3 WORKOUT DESCRIPTIONS

QUICK START

QUICK START is the fastest way to begin exercising, and it bypasses the steps of selecting a specific workout program. The intensity level for the workout is set automatically and remains the same unless manually changed. To change the level, press the UP or DOWN ARROW keys or use the NUMERIC keypad to enter a higher or lower level number. If the METS display is enabled, the MESSAGE CENTER displays “ENTER WEIGHT”, which is required to calculate this value. Using the ARROW KEYS, increase or decrease the displayed weight to the correct value, or enter the weight using the NUMERIC keypad.

FAT BURN

The **FAT BURN** workout is designed to maintain a user's heart rate at 65 percent of the theoretical maximum^{*} for optimal results. Throughout the workout, the user wears a Polar heart rate chest strap or grips the Lifepulse system sensors. If the user is not wearing a chest strap, the WORKOUT PROFILE window displays a heart shape, and the MESSAGE CENTER displays a prompt to grip the sensors. The console continuously monitors and displays the heart rate, adjusting the intensity level of the Lifecycle exercise bike to reach and maintain the target*. This system eliminates over- and under-training, and it maximizes the aerobic benefits of exercise by using the body's fat stores for fuel.

CARDIO

The **CARDIO** workout is virtually identical to **FAT BURN**; however the target heart rate is calculated at 80 percent of the theoretical maximum. The user wears a chest strap or grips the Lifepulse system sensors. The higher target promotes cardiovascular improvement by placing a heavier workload on the heart muscle.

HILL

The Life Fitness-patented **HILL** workout offers a variety of configurations for interval training. Intervals are periods of intense aerobic exercise separated by regular periods of lower-intensity exercise. The WORKOUT PROFILE window represents these high and low intervals as columns of light, which together have the appearance of hills and valleys. The computerized interval training workout has been scientifically demonstrated to promote greater cardio-respiratory improvement than steady-pace training.

Each **HILL** workout goes through four phases, each marked by different intensity levels. The WORKOUT PROFILE window displays the progress of these phases, as seen in the chart following these descriptions below. As noted in the descriptions, the heart rate should be measured at two stages in the workout to gauge its effectiveness. To do so, wear the Polar heart rate chest strap or continuously grip the Lifepulse system sensors. Note that the MESSAGE CENTER does not display a request for a heart rate measurement during a **HILL** workout.

- 1 **Warm-up** is a phase of low, gradually rising resistance, which brings the heart rate into the lower end of the target zone and increases respiration and blood flow to working muscles.
- 2 **Plateau** increases the intensity slightly, and keeps it steady, to bring the heart rate to the low end of the target zone. Check the heart rate at the end of this phase.

^{*} Target Heart Rate (THR) is a percentage of the theoretical maximum. For example, a 40-year-old user's THR for the **FAT BURN** workout is 117. This workout targets 65 percent of the maximum, so the equation would be $(220-40) \times .65 = 117$.

- 3 **Interval Training** is a series of increasingly steeper hills, alternating with valleys, or stints of recovery. The heart rate should rise to the high end of the target* zone. Check the heart rate at the end of this phase.
- 4 **Cool-down** is a low-intensity phase that allows the body to begin removing lactic acid, and other exercise by-products, which build up in muscles and contribute to soreness.

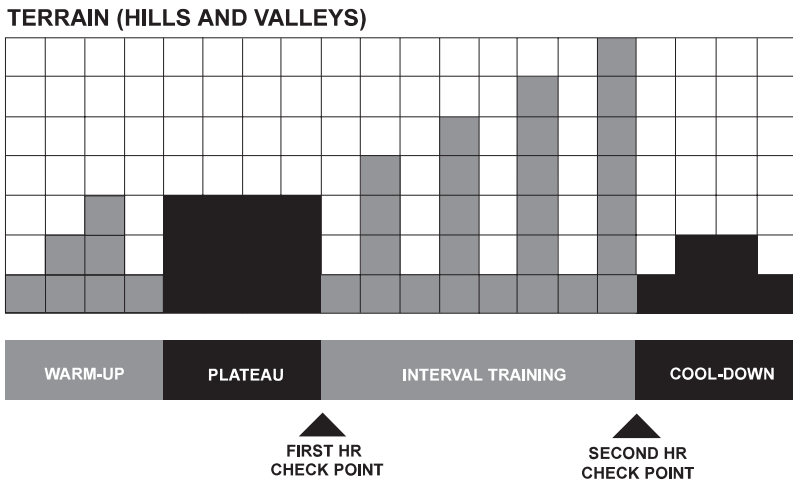

Each column, as seen in the WORKOUT PROFILE window and the chart above, represents one interval. The overall duration of the workout determines the length of each interval. Each workout is made up of 20 intervals, so the duration of each interval is equal to the duration of the entire workout divided by 20.

1 to 9 minutes (available only if Power Assist option is enabled. See the topic titled *Using the Power Assist Option* in Section 1.2.): A workout with a duration of less than 10 minutes is insufficient for the Hill program to complete all four phases adequately. The program, therefore, condenses a workout of this duration at various stages.

10 to 19 minutes: The interval durations initially are set at 30 seconds for a 10-minute workout. For every minute added by the user “on the fly,” each interval increases by three seconds. A 15-minute workout consists of 20 intervals at 45 seconds each.

20 to 99 minutes: All intervals last 60 seconds. If the user adds minutes to the pre-set duration while the workout is in progress, the program adds hills and valleys that are identical to the first eight intervals of the Interval Training phase. This pattern repeats until the workout is completed.

RANDOM

The **RANDOM** program creates a terrain of hills and valleys that varies with each workout. More than one million different patterns are possible.

MANUAL

The **MANUAL** program sets an intensity level that does not change automatically. While the workout is in progress, increase or lower the intensity level as desired, using the arrow keys.

HEART RATE HILL™

This program combines the standard **HILL** workout profile with the concept of Heart Rate Zone Training. The default target heart rate* is calculated as 80 percent of the theoretical maximum† (HRmax), but the user can adjust the target rate during the workout setup. All hills and valleys are percentages of HRmax. The workout consists of three hills that target three heart rate goals: The first hill brings the heart rate to 70 percent of HRmax. The second hill increases the rate to 75 percent of HRmax. The third hill matches the Target Heart Rate bringing the heart rate to 80 percent of HRmax. The valley always is defined as 65 percent of HRmax.

After a standard three-minute warm-up, the workout progresses toward the first hill and heart rate goal. Once the user reaches 70 percent of HRmax, the hill continues for one minute. When the minute expires, the level decreases into a valley. Once the user's heart rate falls to 65 percent of HRmax, the valley continues for one minute. Then, the next hill begins with its corresponding heart rate goal. After the user completes the third hill/valley pair, the program returns to the first hill and repeats the cycle as long as the duration allows. At the end of the duration, the workout goes into a cool-down phase. If the heart rate goes above the theoretical maximum for more than 45 seconds, the exercise bike automatically goes into pause mode. The program does not proceed to a new heart rate goal until the user reaches the current goal.

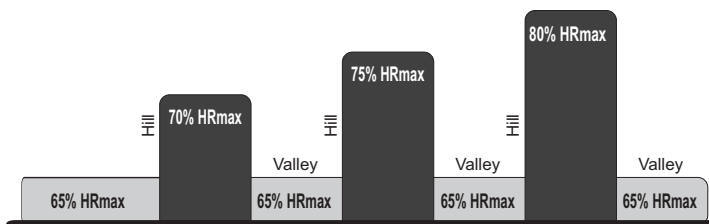

HEART RATE HILL Workout Profile

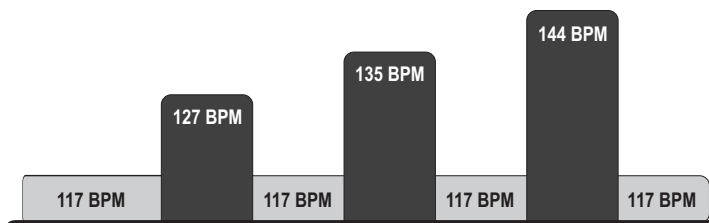

User Example: 80 percent of theoretical maximum (HRmax) (40 year old / 144 recommended BPM)

† Defined by the American College of Sports Medicine's "Guidelines for Exercise Testing and Prescription" as equal to 220 minus an individual's age.

* Target Heart Rate (THR) is a percentage of the theoretical maximum (HRmax). A 40-year-old user's recommended THR for the HEART RATE HILL workout is 144, or 80 percent of the maximum; so the equation would be $(220-40) \cdot 80 = 144$.

HEART RATE INTERVAL™

This program also combines the standard **HILL** workout profile with the concept of Heart Rate Zone Training. The default target heart rate* is calculated as 80 percent of the theoretical maximum† (HRmax), but the user can adjust the target rate during the workout setup. The workout alternates between a hill, which brings the heart rate up to the target rate of 80 percent of HRmax, and a valley, which brings the heart rate down to 65 percent of HRmax. After a standard three-minute warm-up, the workout progresses toward the first hill and heart rate goal. Once the goal is reached, the hill continues for three minutes. Then, the level decreases into a valley. Once the 65 percent of HRmax goal is reached, the valley continues for three minutes, after which the next hill begins. The user's fitness level determines the number of hills and valleys encountered within the duration. At the end of the duration, the workout goes into a cool-down phase. If the heart rate goes above the theoretical maximum† for more than 45 seconds, the exercise bike automatically goes into pause mode. The program does not proceed to a new heart rate goal until the user reaches the current goal.

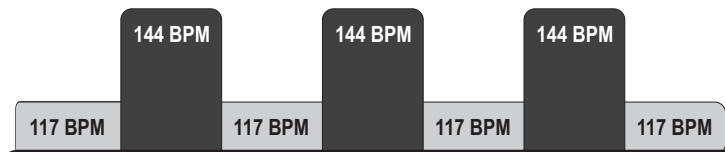
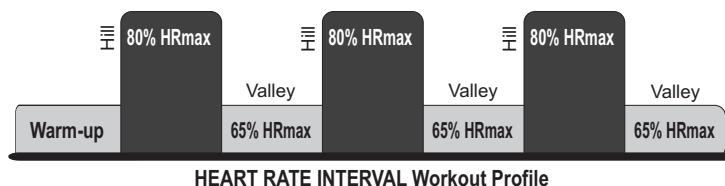

† Defined by the American College of Sports Medicine's "Guidelines for Exercise Testing and Prescription" as equal to 220 minus an individual's age.

* Target Heart Rate (THR) is a percentage of the theoretical maximum (HRmax). A 40-year-old user's recommended THR for the HEART RATE INTERVAL workout is 144, or 80 percent of the maximum; so the equation would be $(220-40) \times 80 = 144$.

EXTREME HEART RATE™

This intense, varied workout is designed to help more experienced users to break through fitness improvement plateaus. The workout alternates between two target heart rates* as quickly as possible. The effect is similar to that of running sprints. The user must wear a chest strap or grip the Lifepulse™ sensors throughout the workout.

When setting up the workout, the user enters a target heart rate. After a standard three-minute warm-up, the intensity increases, until the user reaches the target heart rate goal of 85 percent of the theoretical maximum† (HRmax). That target rate is maintained for a stabilizing period. Then, the intensity decreases. When the heart rate falls to the 65 percent of HRmax goal, it is maintained there for a stabilizing period. The program repeats the alternating of intensity levels, continuing this pattern throughout the duration. The program does not proceed to a new heart rate goal until the user reaches the current goal.

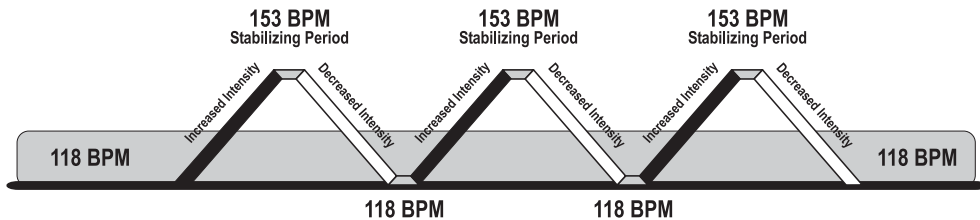
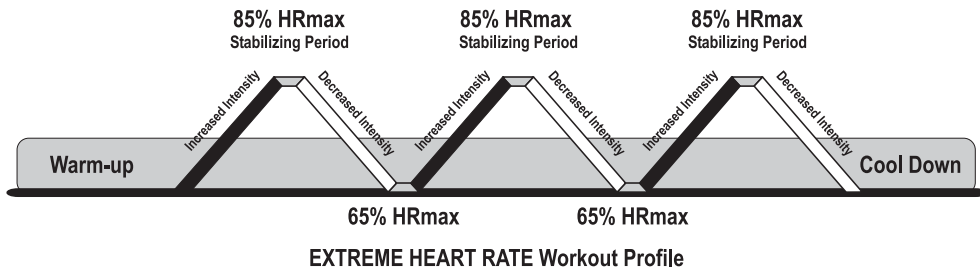

User Example 85 percent of theoretical maximum (HRmax) (40 year old / 153 recommended BPM)

† Defined by the American College of Sports Medicine's "Guidelines for Exercise Testing and Prescription" as equal to 220 minus an individual's age.

* Target Heart Rate (THR) is a percentage of the theoretical maximum (HRmax). For example, a 40-year-old user's recommended THR for the EXTREME HEART RATE™ WORKOUT is 153. The workout program targets a standard 85 percent of the maximum, so the equation would be $(220-40) \cdot 0.85 = 153$.

WATTS

This workout targets a rate of effort equal to a certain number of Watts. A Watt is a unit of power that measures the amount of mechanical work required to operate a device, such as a Lifecycle exercise bike. It is roughly equal to .25 calories per hour. The workout program automatically alters the intensity level to maintain the appropriate rate of effort. By default, this workout is turned off. For information on making it available, see Section 5, titled *Optional Settings*.

METS

This workout targets a rate of effort equal to a certain number of METs. A MET is a unit of measurement used to express the metabolic rate of work (oxygen consumption per unit of body weight) required to perform a task. One MET is approximately equal to a person's metabolism when seated and relaxed. By default, this workout is turned off. For information on making it available, see Section 5, titled *Optional Settings*.

AEROBICS TRAINER

In this workout, the MESSAGE CENTER continuously prompts the user to switch between a high pedaling speed and a low pedaling speed. These speed intervals alternate in a pattern that promotes a "build-up" in the intensity of the workout, followed by a "build-down" in intensity.

The workout consists of 32 intervals, which are divided into groups of four. In the first group, the user encounters one fast interval followed by three slow intervals. The second group features two fast intervals followed by two slow intervals. The third group features three fast intervals followed by one slow interval. The fourth group, which is the most intense point of the workout, features four fast intervals. Afterward, the workout decreases in intensity, concluding with a group of four, consecutive, slow intervals. See the chart below:

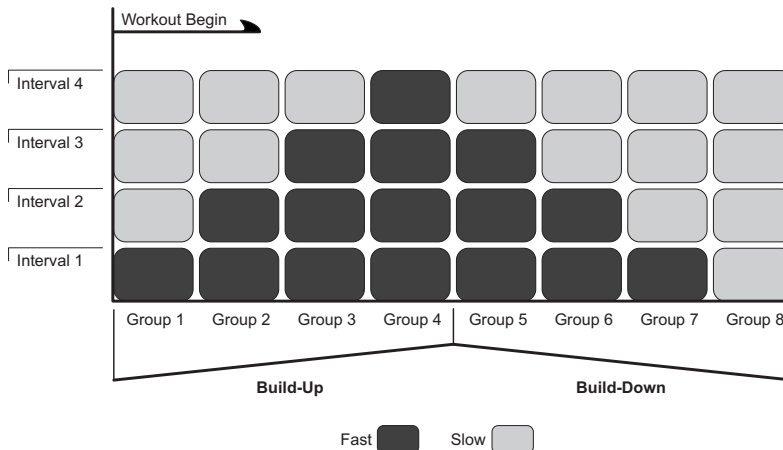

The length of the intervals depends on the workout duration selected by the user.

PERSONAL TRAINER WORKOUTS

Custom interval heart rate and hill workouts may be created by fitness club managers or other authorized personnel. For information about these workouts, consult a fitness club staff member. To select these workouts, press the PERSONAL TRAINER key. When prompted by the MESSAGE CENTER, press the number corresponding to the desired workout, using the NUMERIC keypad. Then, press ENTER and begin the workout. See section 5.2, titled *About Personal Trainer Workouts*.

FIT TEST

The Lifecycle exercise bike Fit Test program is another exclusive feature of this versatile exercise bike. The Fit Test workout measures cardiovascular fitness and can be used to monitor improvements in endurance every four to six weeks. The user must grasp the hand sensors when prompted or wear a heart rate chest strap, as the test score calculation is based on a heart rate reading. The workout duration will be five minutes at the chosen resistance level. Immediately afterward, the console will take the user's heart rate reading, calculate a fitness score, and display the score in the MESSAGE CENTER.

The Fit Test is considered to be a submax VO₂ (volume of oxygen) test. It gauges how well the heart supplies oxygenated blood to the exercising muscles, and how efficiently those muscles receive oxygen from the blood. Physicians and exercise physiologists generally regard this test as a good measure of aerobic capacity. Please note that the estimated VO₂ max scores achieved will be 10 percent to 15 percent lower on stationary exercise bikes than those achieved on other Life Fitness cardiovascular equipment. Stationary cycling has a higher rate of isolated muscle fatigue of the quadriceps when compared to walking/running on a treadmill, climbing on a stairclimber, or utilizing a cross-trainer. This higher rate of fatigue corresponds to lower levels of estimated VO₂ max scores.

To set up the Fit Test:

- Begin pedaling.
- Press the PERSONAL TRAINER button repeatedly until the FIT TEST option appears in the message center. Press ENTER to select the FIT TEST option.
- The message center will prompt for a user weight (ENTER WEIGHT). Use the NUMERIC KEYS or UP/DOWN ARROW KEYS to input your weight. Press ENTER to accept the weight.
- The message center will next prompt for a user age (ENTER AGE). Use the NUMERIC KEYS or UP/DOWN ARROW KEYS to input your age. Press ENTER to accept the age.
- The message center will next prompt for a user gender (SELECT GENDER). Using the UP/DOWN ARROW KEYS, select a gender. Press ENTER to accept the gender selection.
- The message center will next prompt for a workout level (ENTER LEVEL). Consult the following recommended fit test level chart for an appropriate effort level based on your age, gender and activity level. Use the NUMERIC KEYS or UP/DOWN ARROW KEYS to enter the corresponding level.

After the five-minute FIT TEST is completed, a FIT TEST score will be displayed.

FIT TEST PROGRAM SUGGESTED EXERTION LEVELS

	Inactive	Active	Very Active
Bike Fit Test Level	L4-6 men	L5-10 men	L8-14 men
	L2-4 women	L3-7 women	L6-10 women

Suggested exertion levels should be used as a guideline for setting up the Fit Test program. The goal is to elevate the user's heart rate to a level that is between 60%-85% of their theoretical maximum heart rate (220-age).

Within each suggested range, these additional guidelines can be used:

Lower Half of Range	Upper Half of Range
higher age	lower age
lower weight	higher weight*
shorter	taller

* in cases of excessive weight, use lower half of range

The computer will not accept:

- heart rates less than 52 or greater than 200 beats per minute
- body weights less than 75 pounds (34 kg) or greater than 400 pounds (182 kg)
- ages below 10 or over 99 years
- data input that exceeds human potential

If you make an error when entering any Fit Test data, you can correct it by pressing CLEAR, inputting the correct information, and pressing ENTER.

It is important for you to take the Fit Test under similar circumstances each time. Your heart rate is dependent on many factors, including:

- amount of sleep the previous night (at least seven hours is recommended)
- time of day
- time you last ate (two to four hours after the last meal is recommended)
- time since you last drank a liquid containing caffeine or alcohol, or smoked a cigarette (at least four hours is recommended)
- time since you last exercised (at least six hours is recommended)

For the most accurate Fit Test results, you should perform the Fit Test on three consecutive days and average the three scores.

NOTE: *To receive a proper Fit Test score, the work done must be within a training heart rate zone that is 60 percent to 85 percent of the theoretical maximum heart rate. This rate is defined by the American College of Sports Medicine's "Guidelines for Exercise Testing and Prescription" as equal to 220 minus an*

individual's age.

The tables below list fit test results.

RELATIVE FITNESS CLASSIFICATION FOR MEN

Men	Estimated VO2 Max (ml/kg/min) Per Age Category				
Rating	20-29	30-39	40-49	50-59	60+
Elite	52+	51+	48+	45+	42+
Excellent	50-51	48-50	46-47	42-44	39-41
Very Good	47-49	45-47	43-45	40-41	36-38
Above Average	44-46	42-44	40-42	37-39	33-35
Average	41-43	39-41	37-39	34-36	30-32
Below Average	38-40	36-38	34-36	31-33	27-29
Low	35-37	33-35	31-33	28-30	24-26
Very Low	<35	<33	<31	<28	<24

RELATIVE FITNESS CLASSIFICATION FOR WOMEN

Women	Estimated VO2 Max (ml/kg/min) Per Age Category				
Rating	20-29	30-39	40-49	50-59	60+
Elite	44+	42+	39+	35+	34+
Excellent	42-43	40-41	37-38	33-34	32-33
Very Good	39-41	37-39	35-36	31-32	30-31
Above Average	37-38	35-36	32-34	29-30	28-29
Average	34-36	32-34	30-31	27-28	25-27
Below Average	31-33	29-31	27-29	25-26	23-24
Low	28-30	27-28	25-26	22-24	20-22
Very Low	<28	<27	<25	<22	<20

Life Fitness developed this rating scale based on VO2 max percentile distributions referenced in *American College of Sports Medicine's "Guidelines for Exercise Testing and Prescription"* (6th Ed. 2000). It is designed to provide a qualitative description of a user's VO2 max estimation, and a means of assessing initial fitness level and tracking improvement.

MILITARY FITNESS TEST

The 95Ci exercise bike features an Air Force Physical Readiness Tests (PRT). This test is similar to the fit test workout, except that it does not have a preset time goal. The Air Force PRT is located in the Personal Trainer Workouts.

To begin an Air Force PRT:

- Press the Personal Trainer button repeatedly until the Air Force PRT appears in the message center and press ENTER to select the Air Force PRT option.
- The message center will prompt for a user weight (ENTER WEIGHT). Enter a weight between 75 - 400 pounds using the NUMERIC KEYS. Press ENTER to accept the weight.
- The message center will next prompt for a user height (ENTER HEIGHT). Enter a height between 36 - 90 inches using the NUMERIC KEYS. Press ENTER to accept the height.
- The message center will next prompt for a user age (ENTER AGE). Enter an age between 17 - 70 years using the NUMERIC KEYS. Press ENTER to accept the age.
- The message center will next prompt for a user gender (SELECT GENDER). Using the UP/DOWN ARROW KEYS, select a gender. Press ENTER to accept the gender selection.
- The message center will next prompt for a user Fitness Level ("Do you participate in Aerobic Activity at least 20 minutes per session 3+ times per week"). Using the UP/DOWN ARROW KEYS, select 'YES' or 'NO'. Press ENTER to accept the selection.

The Air Force PRT begins after the user selects their Fitness Level and presses ENTER. During the PRT the user must maintain 50-80 RPM. If the user pedals outside this range, a warning message is displayed. If the user continues to pedal outside this range for more than 10 seconds, the test is terminated. If the user's heart rate exceeds 85% of their theoretical maximum heart rate, the test is also terminated. The Air Force PRT requires a user's heart rate throughout the test. Heart rate is recorded every minute, and if it is not detected, the test will terminate. The PRT starts with a 2 minute warm-up. After this warm-up, an initial wattage setting is determined from the user's input data. The PRT then monitors a user's heart rate and determines if more resistance is needed. After 6 minutes at a constant wattage, the exercise bike will try to calculate a score.

SIX PRE-SET WORKOUTS

AROUND THE WORLD, CASCADES, FOOT HILLS, INTERVAL, KILIMANJARO, and SPEED TRAINING are variations of the **HILL** workout. These workouts cannot be changed "on the fly."

AROUND THE WORLD is an interval-training workout in which the hills resemble scenes of various geographical areas.

CASCADES is a two-peak workout in which intensity levels gradually increase and decrease.

FOOT HILLS is a rolling hill workout with low intensity levels.

INTERVAL is a Hill workout in which intensity levels rise and fall. The higher levels gradually incline toward a peak and then gradually decline.

KILIMANJARO is a Hill workout in which the intensity levels gradually incline toward one ultimate peak and then gradually decline.

SPEED TRAINING is a Hill workout in which the intensity level alternates between high and low levels very quickly to simulate a typical speed-training workout.

5 OPTIONAL SETTINGS

5.1 ENTERING AND USING THE OPTIONAL SETTINGS FEATURE

Fitness club managers and other authorized personnel can use the Optional Settings feature to change default settings, or to enable or disable certain programs or displays on the bike console.

To enter the Optional Settings, while the unit is on, hold down the “5” key on the NUMERIC keypad, press CLEAR twice and press ENTER. The MESSAGE CENTER displays OPTIONAL SETTINGS, and then, the first configuration option. Scroll forward through the options using the ENTER key, or backward, using the CLEAR key. For each feature or setting option, the MESSAGE CENTER displays the default setting. To change the default, press an ARROW key for the desired value, or use the NUMERIC keypad. Press ENTER to select the new value or setting.

To exit Optional Settings, press the CLEAR key repeatedly until the MESSAGE CENTER displays “SELECT WORKOUT OR PRESS QUICK START”.

OPTIONAL SETTINGS		
Setting	Default Value	Description
MAX WORKOUT DURATION	60 minutes	This is the maximum possible duration for a workout. The value can range from 1 to 99.
ENGLISH/METRIC UNITS	ENGLISH	This option determines the units of weight measurement used by workout programs.
WATTS DISPLAY ENABLE/DISABLE	ENABLED	If this option is enabled, the MESSAGE CENTER displays the Watts equivalent of the pedal rate.
METS DISPLAY ENABLE/DISABLE	DISABLED	If this option is enabled, the MESSAGE CENTER displays the METs equivalent of the pedal rate.
WATTS PROGRAM ENABLE/DISABLE	DISABLED	If this option is enabled, the Watts program becomes an available workout on the bike.
METS PROGRAM ENABLE/DISABLE	DISABLED	If this option is enabled, the METs program becomes an available workout on the bike.
CAL/HR DISPLAY ENABLE/DISABLE	DISABLED	If this option is enabled, the MESSAGE CENTER displays the number of calories burned per hour during the workout.
AIR FORCE PRT ENABLE/DISABLE	ENABLED	If this option is enabled, the FITNESS TEST: AIR FORCE PRT program becomes an available workout on the bike.

5.2 ABOUT PERSONAL TRAINER WORKOUTS

Fitness club managers and other authorized personnel can create up to six custom workouts for the Lifecycle exercise bike, using the display console. Options include custom interval heart rate and hill workouts.

Interval heart rate: The trainer can design a workout that sets a different target heart rate for each interval and adjusts the resistance to the user's heart rate.

Hill: The trainer can create a custom hill workout that sets a different intensity level for each interval.

Once **PERSONAL TRAINER** workouts are created, users can access them with the PERSONAL TRAINER key. Each workout is identified by a numeral, from 1 to 6. See Section 4, titled *The Workouts*.

TO CREATE A PERSONAL TRAINER WORKOUT

When the console is activated, hold down the COOL DOWN button, and press the PERSONAL TRAINER button simultaneously.

Using the ARROW keys, scroll to, and select, the "PERSONAL TRAINER WORKOUT ENTRY" option, and press ENTER. (If the alternate option, "ERASE PERSONAL TRAINER WORKOUTS", is selected, the computer deletes setup information for all **PERSONAL TRAINER** workouts, and the MESSAGE CENTER displays "PERSONAL TRAINER WORKOUTS ERASED". Then, the MESSAGE CENTER displays "PERSONAL TRAINER WORKOUT ENTRY").

Select a number, from 1 to 6, to identify the new workout. Use the NUMERIC keypad or the ARROW keys. Then, press ENTER.

If a **PERSONAL TRAINER** workout already has been created for that number, the MESSAGE CENTER displays a prompt to either modify the workout or proceed to another number. Pressing the CLEAR key overwrites the previously created workout, making it possible to create a new workout for that number. Pressing ENTER bypasses the number and proceeds to another number.

If a **PERSONAL TRAINER** workout has not been created for a selected number, the MESSAGE CENTER displays the prompt, "BEGIN PERSONAL TRAINER WORKOUT CREATION".

The MESSAGE CENTER displays a prompt to enter a duration time for the entire workout. Using the NUMERIC keypad, enter a duration and press ENTER.

The MESSAGE CENTER displays a prompt to select the workout type. Options are "TARGET HEART RATE PERCENTAGE" or "LEVEL". The latter type is for custom hill workouts. Use the ARROW keys to toggle between the options, and press ENTER to select one of them.

The MESSAGE CENTER displays a prompt to select a target heart rate or an intensity level for the first interval, depending on the type of workout chosen in an earlier step. Use the ARROW keys or the NUMERIC keypad. A **PERSONAL TRAINER** workout consists of 30 intervals, so the length of each interval is equal to the workout duration value divided by 30. After entering the value, press ENTER. Repeat this set of steps for each of the following 29 intervals. To keep the preceding value for the current interval, simply press ENTER.

At the end of this setup, the MESSAGE CENTER displays "PERSONAL TRAINER WORKOUT COMPLETED". Afterward, the MESSAGE CENTER displays "SELECT WORKOUT OR PRESS QUICK START". The new **PERSONAL TRAINER** workout is ready to use.

6 SERVICE AND TECHNICAL DATA

6.1 PREVENTATIVE MAINTENANCE TIPS

The Lifecycle Exercise Bike is backed by the engineering excellence of Life Fitness and is one of the most rugged and trouble-free pieces of exercise equipment on the market today. Commercial Life Fitness products have proven to be durable in health clubs, colleges, and military facilities the world over. This same technology, engineering expertise, and reliability have gone into the Lifecycle Exercise Bike.

NOTE: *The safety of the equipment can be maintained only if the equipment is examined regularly for damage or wear. Keep the equipment out of use until defective parts are repaired or replaced. Pay special attention to parts that are subject to wear as outlined in the Preventive Maintenance Schedule.*

The following preventive maintenance tips will keep the Lifecycle exercise bike operating at peak performance:

- Locate the bike in a cool, dry place.
- Keep the pedal straps fastened securely when using the bike.
- Keep the display console free of fingerprints and salt build-up caused by sweat.
- Use a **100% cotton cloth**, lightly moistened with water and mild liquid detergent, to clean the bike. Other fabrics, including paper towels, may scratch the surface.
Do not use ammonia or acid-based cleaners.
- Long fingernails may damage or scratch the surface of the console; use the pad of the finger to press the selection buttons on the console.
- Clean the housing thoroughly on a regular basis.

NOTE: *A non-abrasive cleaner and soft cotton cloth are strongly recommended for cleaning the exterior of the unit. At no time should cleaner be applied directly to any part of the equipment; apply the non-abrasive cleaner on a soft cloth, and then wipe the unit.*

6.2 PREVENTATIVE MAINTENANCE SCHEDULE

Follow the schedule below to ensure proper operation of the product.

Follow the schedule below to ensure proper operation of the product.				
ITEM	WEEKLY	MONTHLY	BI-ANNUALLY	ANNUALLY
<i>Display Console</i>	C	I		
<i>Console Mounting Bolts</i>			I	
<i>Accessory Tray</i>	C	I		
<i>Frame</i>	C			I
<i>Plastic Covers</i>	C	I		
<i>Pedals and Straps</i>	C	I		

KEY: C=Clean; I=Inspect

6.3 TROUBLESHOOTING THE POLAR HEART RATE CHEST STRAP

HEART RATE READING IS ERRATIC OR ABSENT ENTIRELY

- Repeat the electrode moistening procedure. See Section 3.2, titled *Heart Rate Monitoring* for details. The electrodes must remain wet to pick up and transmit accurate heart rate readings.
- Make sure the electrodes are flat against the skin.
- Wash the belt transmitter regularly with mild soap and water.
- Make sure the chest strap transmitter is within three feet, or one meter, of the heart rate receiver.
- The chest strap is battery-operated and will stop functioning when the battery runs out. Contact Life Fitness Customer Support Services for instructions on how to have the chest strap replaced. See section 6.5, titled *How to Obtain Product Service*.

HEART RATE READING IS ERRATIC OR EXTREMELY HIGH

If the chest strap is worn near sources of electromagnetic signals, these signals may be strong enough to affect heart rate readings. Possible sources include:

- Television sets and/or antennas, cell phones, computers, cars, high voltage power lines and motor driven exercise equipment.
- Another heart rate transmitter within three feet, or one meter, may also cause abnormal heart rate readings.

6.4 TROUBLESHOOTING THE LIFEPULSE SYSTEM SENSORS

If the heart rate reading is erratic or missing, do the following:

- Dry moist hands to prevent slipping.
- Apply hands to both sensors, one in each hand.
- Grasp the sensors firmly.
- Apply constant pressure around the sensors.

6.5 RECYCLING THE BATTERY

When this Life Fitness product is about to be discarded at the end of its useful life, the rechargeable battery must first be removed and recycled. If an optional external power supply is present, it must be disconnected before the battery is removed. To access the battery, remove the right-side pedal crank and shroud. To remove the battery, disconnect the cable, and remove the two screws holding the battery to the bracket.

6.6 HOW TO OBTAIN PRODUCT SERVICE

1. Verify the symptom and review the operating instructions. The problem may be unfamiliarity with the product and its features and workouts.
2. Locate and document the serial number of the unit. This number consists of three letters followed by six numbers. The serial number plate is located on the front stabilizer at the bottom of the unit.
3. Contact Life Fitness Customer Support Services via the Web at: www.lifefitness.com, or call the nearest Life Fitness Customer Support Services group:

For Product Service within
the United States and Canada:

Telephone: (+1) 847.451.0036
FAX: (+1) 847.288.3702
Toll-free telephone: 800.351.3737

For Product Service Internationally:

Life Fitness Europe GmbH
Telephone: (+49) 089.317.751.66
FAX: (+49) 089.317.751.38

Life Fitness (UK) LTD
Telephone: (+44) 1353.665507
FAX: (+44) 1353.666018

Life Fitness Atlantic BV
Life Fitness Benelux
Telephone: (+32) 03.644.44.88
FAX: (+32) 03.644.24.80
Telephone: (+32) 87.300.942
FAX: (+32) 87.300.943

Life Fitness Italia S.R.L.
Telephone: (+39) 0472.835.470
FAX: (+39) 0472.833.150
Toll-free telephone: 800.438836

Life Fitness Vertriebs GmbH
Telephone: (+43) 1615.7198
FAX: (+43) 1615.7198.20

Life Fitness Asia Pacific Ltd
Telephone: (+852) 2891.6677
FAX: (+852) 2575.6001

*Life Fitness Latin America
and Caribbean*
Telephone: (+1) 847.288.3964
FAX: (+1) 847 288.3886

Life Fitness Brazil
Telephone: (+55) 11.7295.2217
FAX: (+55) 11.7295.2218

Life Fitness Japan
Telephone: (+81) 3.3359.4306
FAX: (+81) 3.3359.4307

Life Fitness Iberia
Telephone : (+34) 93 672 4660
FAX : (+34) 93 672 4670

7 SPECIFICATIONS

7.1 95Ci LIFECYCLE EXERCISE BIKE SPECIFICATIONS

Designed use:	Heavy/Commercial
Maximum user weight:	400 pounds / 181 kilograms
CONSOLE:	
Type:	Numeric keypad and arrow keys
Displays:	MESSAGE CENTER with heart rate, distance, Revolutions Per Minute (RPM), calories, calories per hour (when enabled), Watts (when enabled), and METs (when enabled) WORKOUT PROFILE TIME/LEVEL WINDOW
Summaries:	Total elapsed time of workout, total calories burned, total distance
Character size:	0.54 inches
Workouts:	Quick Start, Fat Burn, Cardio, Manual, Random, Hill, Heart Rate Hill, Heart Rate Interval, Heart Rate Extreme, Watts (when enabled), METS (when enabled), Around the World, Foothills, Kilimanjaro, Interval, Cascades, Speed Training, Fit Test, Military Fitness Test (when enabled)
Heart rate monitor:	Polar telemetry heart rate monitoring system Lifepulse system sensors Polar heart rate chest strap (optional)
Intensity levels:	25
Pedal size	5 inches x 5.5 inches / 127 millimeters x 140 millimeters
Drive type:	Belt/alternator
Accessory Tray:	Standard
Color:	Gray / Silver
ASSEMBLED DIMENSIONS:	
Length	48 inches / 122 centimeters
Width	24 inches / 61 centimeters
Height	54 inches / 137 centimeters
Weight	107 pounds / 49 kilograms
SHIPPING DIMENSIONS:	
Length	48 inches / 122 centimeters
Width	22 inches / 56 centimeters
Height	37 inches / 94 centimeters
Weight	134 pounds / 61 kilograms



M051-00K63-A064

Life Fitness World Headquarters
10601 W. Belmont Avenue
Franklin Park, IL 60131